



Components for the food industry. [Reliable technology and sanitary design.](#)

# ➤➤ Bulk material components for conveying and discharging foodstuffs must satisfy very high demands with regard to sanitation and reliability. Coperion is the right partner for all such applications.

Coperion is the worldwide leading manufacturer of bulk material components, and is familiar with the properties and behaviour of more than 10,000 different bulk materials. Parameters such as particle size, cohesion and adhesion influence the flow properties and therefore the correct design and layout of bulk material components. Our intensive research and the

development of new technologies has resulted in innovative and easy-to-clean process components produced on our own premises which set standards in the industry. This means that your products are handled as sanitary and gently as possible in keeping with the very latest technical standards.

## EXAMPLE APPLICATIONS FOR OUR COMPONENTS

### > LOGISTICS SYSTEM

- 1 Rotary valve
- 2 Diverter valve
- 3 Slide gate valve
- 4 Sampler

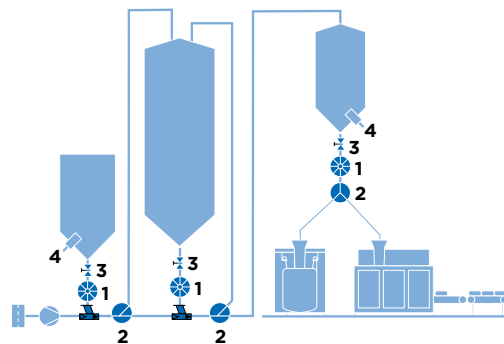

### > MILL WITH EXPLOSION PROTECTION

- 1 Rotary valve as ATEX protection system
- 2 Slide gate valve

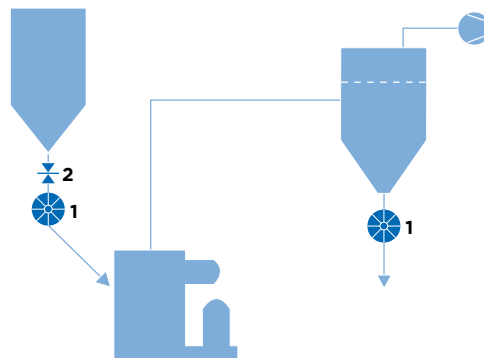

### > SPRAY-DRYING SYSTEM

- 1 Rotary valve for CIP application
- 2 Diverter valve for CIP application

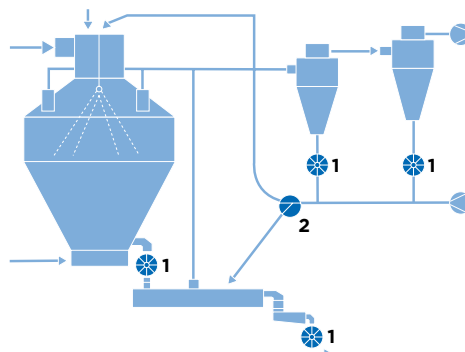

## EXAMPLES OF CONVEYED PRODUCTS:

### Dairy products

- > Milk powder
- > Whey powder
- > Lactose
- > Babyfood
- > Casein
- > ...

### Starch

- > Maize starch
- > Potato starch
- > Wheat starch
- > Modified starch
- > Dextrine
- > ...

### Basic materials and additives

- > Sugar
- > Flour
- > Coffee beans and ground coffee
- > Malt
- > Cocoa beans and powder
- > Salt
- > Rice
- > Tea
- > Tobacco
- > Soya beans
- > Nuts
- > Herbs
- > Pectin
- > Gelatine
- > ...

### Convenience products

- > Cake mixes and baking powder
- > Soups
- > Instant potato
- > Instant products
- > Breadcrumbs
- > Spices and mixed spices
- > Cereals
- > Pet food
- > ...

## PERFECT CONVEYING AND DISCHARGE: COPERION ROTARY VALVES

### BLOW-THROUGH VALVE

**ZXD** FOR POWDER

- › Optimum chamber emptying with specially designed blow-through channel, ideal for products with poor flow properties
- › Extra-large inlet for high throughputs
- › Can be used without leakage gas collector



### DISCHARGE AND CONVEYING VALVE

**ZRD** FOR POWDER

- › Smooth surfaces
- › Outside bearings, gas-purged
- › With pick-up tee for pneumatic conveying systems up to +1.5 bar (g)



### DISCHARGE AND CONVEYING VALVE

**ZVD** FOR POWDERS AND COARSE PRODUCTS

- › Product-gentle inlet geometry
- › Start-up from a stationary product column
- › Integrated leakage gas venting



- › Materials available: stainless steel, aluminium, grey cast iron, chrome-plated grey cast iron, nickel-plated grey cast iron
- › Option: surfaces with wear protection or Teflon coating
- › Hygienic series: polished surfaces ( $R_a \leq 0,8 \mu\text{m}$ )
- › All rotary valves suitable for pneumatic conveying up to 1.5 bar (g)

## OPTIONS:

### QUICK-CLEANING

- Fast and simple cleaning:
- › Rotor with quick coupling
- › FullAccessSystem FXS-1 hinge extraction device
- › Removable rotor
- › Hinged drive side plate FXS-2
- › Cleaning cover

### CERTIFIED ROTARY VALVES ESPECIALLY FOR CLEANING IN PLACE

- › Ideal for the highest sanitary and product quality demands
- › For fully automatic wet cleaning without dismantling the valve
- › For frequent cleaning – saves time and money
- › EHEDG approved and certified (EL Class I)

### ACCESSORIES

- › Chamfered rotor blades
- › Rotor with scraper blades for caking products
- › Rotor with reduced volume
- › Wear-protected versions
- › RotorCheck: electronic contact monitoring of rotor and housing

### ATEX-CERTIFIED VERSIONS

- › Inside: zone 0/20 (II1GD), Outside: zone 1/21 (II1GD), or zone 2/22 (II3GD)
- › ATEX protection system: pressure surge-proof up to +10 bar and flame surge-proof St1 and St2

› QUICK-CLEANING

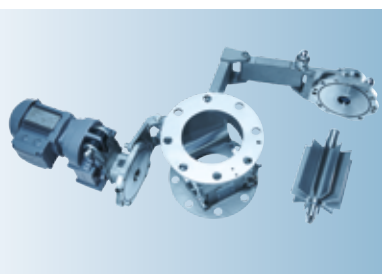

› CLEANING IN PLACE

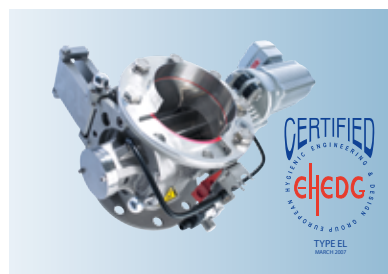

› ACCESSORIES

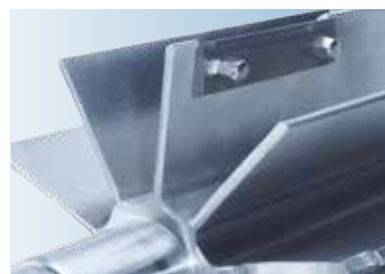

› ATEX

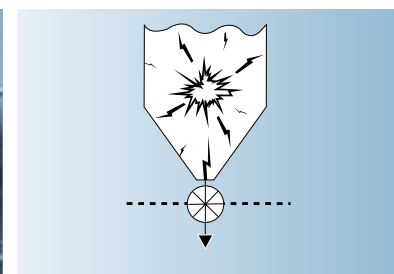

## GIVING THE RIGHT DIRECTION: COPERION DIVERTER VALVES

### TWO-WAY DIVERTER VALVE WZK

- › Parts in contact with product made of stainless steel, aluminium housing
- › DN 50 (2") to DN 265 (10")
- › For pneumatic conveying systems up to +5 bar
- › Smooth, easy-to-clean surfaces



### TWO-WAY DIVERTER VALVE WYK

- › Made entirely of stainless steel
- › DN 65 (2.5") to DN 125 (5")
- › For pneumatic conveying systems up to +5 bar
- › Also available as WYK-CIP for cleaning in place!

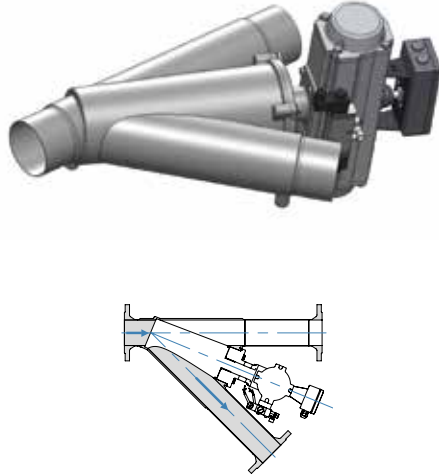

### TWO-WAY DIVERTER VALVE WHK

- › Made entirely of stainless steel
- › DN 150 (6") to DN 350 (14")
- › For gravity pipes or pneumatic conveying systems up to +3 bar

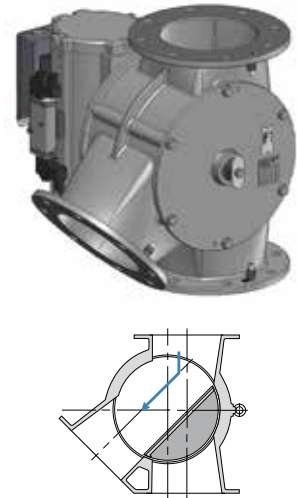

### QUICK-CLEANING AS STANDARD FEATURE:

The cover can be opened quickly and easily and the rotary element can be removed, making cleaning and inspection fast and simple.

### OPTIONAL: CIP-CERTIFIED DIVERTER VALVE WYK

- › For the highest sanitary and quality requirements
- › CIP design and CIP drive permit fully-automatic wet cleaning without dismantling the valve
- › Certified for CIP by the EHEDG (EL Class I)

### EXAMINE PRODUCT QUALITY: SAMPLER PN 80

- › For regular extraction of product samples from the silo cone or gravity pipe
- › Material: aluminium or stainless steel
- › Option: quick cleaning

### SHUTTING OFF PRODUCT FLOW: SLIDE GATE VALVE FUS

- › Basic shut-off slide valve for silos and hoppers
- › DN 100 (4") to DN 600 (24")
- › Made of stainless steel

› WYK-CIP (DISMANTLED)

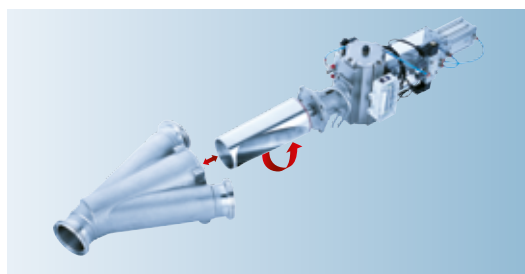

› SAMPLER

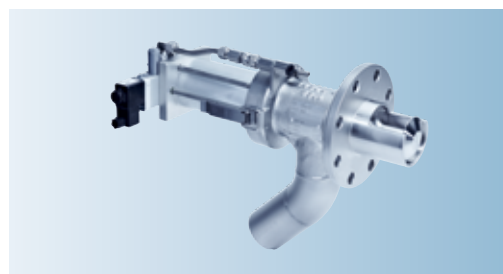

› SLIDE GATE VALVE



➤➤ Innovative technology for optimum operational safety: Coperion components for the food industry. With our many years of experience and all-around process know-how we are able to supply individual and efficient solutions for your production which are operationally safe and reliable, sanitary and easy to clean.

**YOUR BENEFITS:**

- › Sanitary product design
- › Operational reliability and durability
- › Easy to clean: fast, efficient cleaning and inspection due to optimum accessibility
- › Certified CIP versions (cleaning in place)

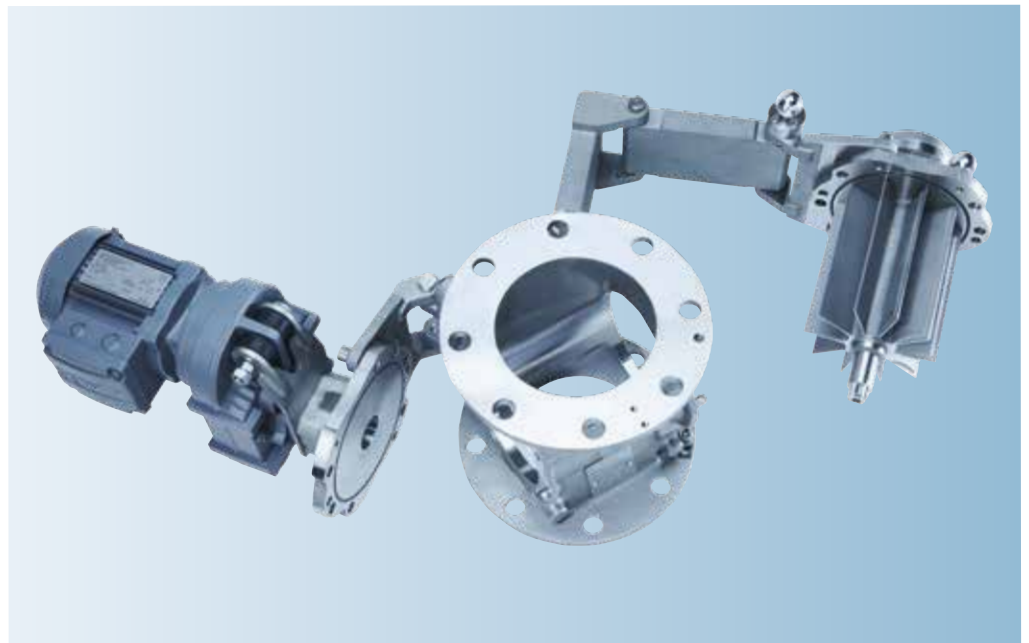

**EHEDG AND USDA COMPLIANT AND CERTIFIED VERSIONS AVAILABLE**

Coperion is an active member of the European Hygienic Engineering & Design Group. The latest developments and directives are therefore directly incorporated into the development of all components.

The USDA (United States Department of Agriculture) Dairy Grading Branch certifies components on the basis of stringent regulations regarding sanitary and easy-clean design.



**Coperion GmbH**

Theodorstrasse 10  
70469 Stuttgart, Germany  
Tel.: +49 711 897-0  
Fax: +49 711 897-3999

**Coperion GmbH**

Niederbieger Strasse 9  
88250 Weingarten, Germany  
Tel.: +49 751 408-0  
Fax: +49 751 408-200

info@coperion.com  
www.coperion.com

> Europe

Belgium, Luxembourg, Netherlands  
**Coperion N.V.**  
Industrieweg 2, 2845 Niel, Belgium  
Tel.: +32 3 870-5100  
Fax: +32 3 877-0710

France

**Coperion S.a.r.l.**  
56 boulevard de Courcerin  
77183 Croissy-Beaubourg, France  
Tel.: +33 164 801 600  
Fax: +33 164 801 599

Germany

**Coperion GmbH**  
**Germany West Office**  
Industriestrasse 71a  
50389 Wesseling, Germany  
Tel.: +49 2232 20700-10  
Fax: +49 2232 20700-11

**Coperion Pelletizing Technology GmbH**

Heinrich-Krumm-Strasse 6  
63073 Offenbach, Germany  
Tel.: +49 69 989 5238-0  
Fax: +49 69 989 5238-25

**Coperion K-Tron Deutschland GmbH**

Heinrich-Krumm-Strasse 6  
63073 Offenbach, Germany  
Tel.: +49 69 8300 899-0  
Fax: +49 69 8300 9498

Italy

**Coperion S.r.l.**  
Via E. da Rotterdam, 25  
44122 Ferrara, Italy  
Tel.: +39 0532 7799-11  
Fax: +39 0532 7799-80

**Coperion S.r.l.**  
**Milan Office**

Via XXV Aprile, 49  
20091 Bresso (MI), Italy  
Tel.: +39 02 241 049-01  
Fax: +39 02 241 049-22

Russian Federation, CIS

**OOO Coperion**  
Proezd Serebryakova 14,  
Bld. 15, Office 219  
129343 Moscow, Russian Federation  
Tel.: +7 499 258 4206  
Fax: +7 499 258 4206

Spain, Portugal

**Coperion, S.L.**  
Balmes, 73, pral.  
08007 Barcelona, Spain  
Tel.: +34 93 45173-37  
Fax: +34 93 45175-32

Switzerland

**Coperion K-Tron (Schweiz) GmbH**  
Lenzhardweg 43/45  
5702 Niederlenz, Switzerland  
Tel.: +41 62 8857-171  
Fax: +41 62 8857-180

United Kingdom

**Coperion Ltd.**  
**Coperion K-Tron Great Britain Ltd.**  
Unit 4, Acorn Business Park  
Heaton Lane  
Stockport, SK4 1AS, United Kingdom  
Tel.: +44 161 209 4810  
Fax: +44 161 474 0292

> Asia

China

**Coperion (Nanjing) Machinery Co. Ltd.**  
No. 1296 Jiyin Avenue  
Jiangning District  
Nanjing 211106, PR China  
Tel.: +86 25 5278 6288  
Fax: +86 25 5261 1188

**Coperion International Trading (Shanghai) Co. Ltd.**

**Coperion Machinery & Systems (Shanghai) Co. Ltd.**  
Bldg. A2, 6000 Shenzhuan Road  
Dongjing Town, Songjiang District  
Shanghai 201619, PR China  
Tel.: +86 21 6767 9505  
Fax: +86 21 6767 9108

**Coperion K-Tron (Shanghai) Co. Ltd.**

Building A2-A3  
No. 6000 Shen Zhuan Gong Road  
Songjiang District  
201619 Shanghai, PR China  
Tel.: +86 21 6375 7925  
Fax: +86 21 6375 7930

India

**Coperion Ideal Pvt. Ltd.**  
Ideal House, A-35, Sector 64  
201307 Noida (U.P.), India  
Tel.: +91 120 4299 333  
Fax: +91 120 4308 583

Japan

**Coperion K.K.**  
4F, Leaf Square Shin-Yokohama Bldg.  
3-7-3, Shin-Yokohama,  
Kohoku-ku Yokohama,  
Kanagawa 222-0033, Japan  
Tel.: +81 45 595 9801  
Fax: +81 45 595 9802

Saudi Arabia

**Coperion Middle East Co. Ltd.**  
Street # 327, Sector G, Block 2, Lot # 31  
Jubail 2 Industrial City,  
Kingdom of Saudi Arabia  
Tel.: +966 13 510 4420  
Fax: +966 13 510 4421

Singapore

**Coperion Pte. Ltd.**  
**Coperion K-Tron Asia Pte. Ltd.**  
8 Jurong Town Hall Road  
#28-01/02/03 The JTC Summit  
Singapore 609434  
Tel.: +65 641 88-200  
Fax: +65 641 88-203

Taiwan

**Coperion (Nanjing) Machinery Co. Ltd.**  
**Taiwan Branch Office**  
5F, No. 43, Alley 115  
Chung San North Road Sec. 2  
Taipei, Taiwan  
Tel.: +886 2 2521 3580  
Fax: +886 2 2521 1604

> America

South America

**Coperion Ltda.**  
R. Arinos, 1000  
RBCA - Royal Business Center  
Anhanguera, Módulo 4  
Parque Industrial Anhanguera  
06276-032 Osasco - SP, Brazil  
Tel.: +55 11 3874-2740  
Fax: +55 11 3874-2757

USA, Canada, Mexico, NAFTA  
**Coperion Corporation**  
590 Woodbury Glassboro Road  
Sewell, NJ 08080, USA  
Tel.: +1 201 327-6300  
Fax: +1 201 825-6494

**Coperion Corporation Wytheville Office**

196 Appalachian Drive  
Wytheville, VA 24382, USA  
Tel.: +1 276 228-7717  
Fax: +1 276-227-7044

**Coperion Corporation Houston Office**

7900 North Sam Houston Pkwy, West  
Suite 202  
Houston, TX 77064, USA  
Tel.: +1 281 449-9944  
Fax: +1 281 449-4599

**Coperion K-Tron Pitman, Inc.**

590 Woodbury Glassboro Road  
Sewell, NJ 08080, USA  
Tel.: +1 856 589-0500  
Fax: +1 856 589-8113

**Coperion K-Tron Salina, Inc.**

606 North Front Street  
Salina, KS 67401, USA  
Tel.: +1 785 825-1611  
Fax: +1 785 825-8759

For more information about  
the worldwide Coperion network,  
visit [www.coperion.com](http://www.coperion.com)